

stock displays

solutions guide



siffron[®]

www.siffron.com | 800.422.2547



new

4eBin™ Gravity Bin



new

Scoop Bin



new

Pole Star® Spinner Display



new

Impluse QueueLane™

Stock Displays

A Wide Array of Free-Standing Display Options to Highlight Merchandise

Showcasing your store's inventory while making it appealing to your customers can be an ongoing struggle. Consider using attention-getting display racks, grid panels and grid displays to merchandise your products. Siffron carries a wide variety of stock displays, such as spinner displays, wire racks, dump bins, and wood displays that can be moved from department to department as needed.

- ◆ Wire merchandising racks
- ◆ Economy dump bins
- ◆ Grid displays
- ◆ Spinner Displays
- ◆ Specialty Displays

This guide includes a wide variety of products to help you maximize impact with minimal use of space.



4eBin™ Gravity Bin	4
Scoop Bins	8
GoMix™ Pick & Mix Display	10
Visi-Bin™	11
Fastrack®	16
Pole Star® Spinner Display	26
All-Wire Spinner Display	28
Bowl Tower Display	29
Clear Bowl Display	30
Grid Displays	31
Universal Upright System	35
Impulse QueueLane™	36
Mobile Racks	38
Wire Counter Racks	40
Wire Floor Racks	41
Wire Dump Bins.	44
Wall Baskets	46
Wicker Basket Displays	48
Bag Displays	50





Revolutionary new easy-clean design

4eBin™ Gravity Bin

A bulk offering is an effective use of store space and creates differentiation. Introducing bulk bins as an easy way of enlarging or adapting your product offering to meet the needs of your local market demands.

Create destinations within your store where shoppers can engage fully with pick & mix of nuts, candies or cereals. Not only do bulk bins encourage greater interaction, they also give consumers more freedom to purchase the exact combination and quantity of the product they want.

Ecological A more “eco-friendly” way of shopping. Fewer resources are used in both transport and packaging.

Economical Lets shoppers buy their desired quantity and favorite mix.

Ergonomic A delight to handle for shoppers and store personnel alike.

Easy-Clean Revolutionary design allows for cleaning the bin without removing them from the shelf.



The GB4e100-12, 5L product is NSF Certified under HL Display Gilwice Sp. Z.o.o.

STOCK DISPLAYS

Why bulk bins are so effective:

- Product visibility stimulates impulse purchases
- First in / first out product guaranteed
- Ergonomic and anti-microbial pull handle provides a consumer friendly interaction
- Easy to install using a cross-bar system or your existing shelving
- Easy cleaning thanks to innovative design

Easy to
install
and
maintain!

Up to **30%**
Time Saving
(Compared to bins in the market)

4eBin™ Gravity Bin Features and Benefits



Features	Benefits
Bin fully assembled (1)	Easier mounting and dismounting
Ergonomic front cover	Easier to remove for cleaning
False front*	Bins always look full and displays the content
Dust proof lid	Designed to avoid dust / dirt traps

Features	Benefits
Smooth design of the nozzle (2)	More compact design
Ergonomic pull handle (3)	Provides a consumer friendly dispensing action
Easy refilling (4)	Removable lid with open / close function and refilling position
Stock level (5)	Remaining stock can be read from side of bin

*Optional feature to have a full face display even at low stock levels

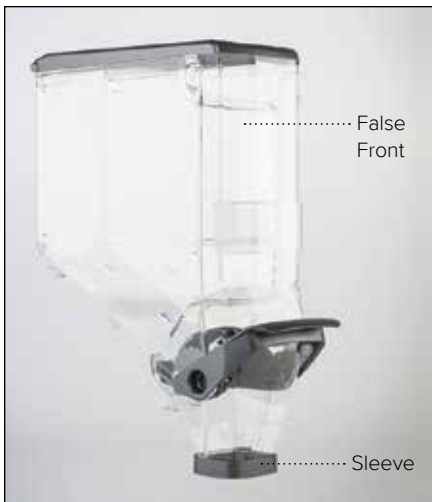

4eBin™ Gravity Bin Specifications

- Available in 2.0, 3.3 and 5.3 gallons
- Hygienic closed system - consumers can see, but not touch the product unless buying
- All models available with or without false front depending on customer needs
- Standard flow control and ergonomic handle for optimal shopping experience and shrink reduction (first in / first out principle)
- A 5 gallon bin can sustain 44lbs of merchandise
- Transparent body; top lid, handle and sleeves are black as standard
- Additional color options available upon request
- US and European food contact certification (all bins are BPA/EA-free)
- Label printing area 5.5" W x 2.28" H (label holder for 6" wide bins)

Item No.	False Front	Sleeve	Dimensions	Capacity	Pack
4630940105	Yes	Yes	3.9" W x 20.7" H x 14.6" D	2 Gal (7.5 L)	1
4639171747	Yes	Yes	3.9" W x 26.6" H x 14.6" D	3.3 Gal (12.5 L)	1
4632968055	Yes	Yes	5.9" W x 21.1" H x 13.8" D	3.3 Gal (12.5 L)	1
4639138967	Yes	Yes	5.9" W x 28" H x 13.8" D	5.3 Gal (20 L)	1

Additional sizes are available (call for details)



Crossbar with Mounting Bracket

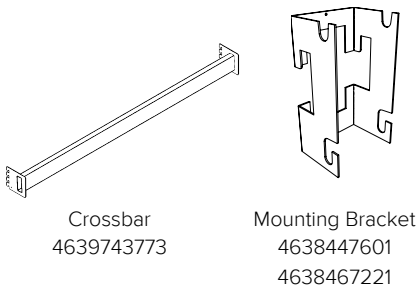

Crossbar
4639743773

Mounting Bracket
4638447601
4638467221



Crossbar with Swing Down Arm

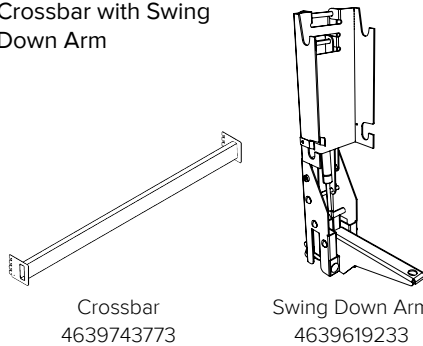

Crossbar
4639743773

Swing Down Arm
4639619233



Shelf Mount Foot with Back Rail

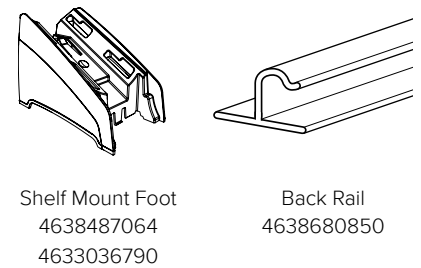

Shelf Mount Foot
4638487064
4633036790

Back Rail
4638680850

4eBin™ Gravity Bin Mounting Options

Crossbar with Mounting Bracket

- Crossbar is 48" L
- Place the mounting bracket on the crossbar and hang bin
- Install on crossbars when whole sections of bins are to be installed

Crossbar with Swing Down Arm

- Place the swing down arm on the crossbar and hang bin
- Easiest mounting method to check stock levels
- Installing swing down arms is the preferred option for upper levels

Shelf Mount Foot with Back Rail

- Foot in combination with the rail locks the bin in place
- Mounting foot will rest on shelf
- Fasten rail to back of shelf with push pins (sold separately)

Item No.	Style	Pack
4639743773	Crossbar	1
4638447601	Mounting Bracket 4"	1
4638467221	Mounting Bracket 6"	1
4638467221	Swing Down Arm 4"	1
4639619233	Swing Down Arm 6"	1
4638487064	Shelf Mount Foot 4"	1
4633036790	Shelf Mount Foot 6"	1
4638680850	Shelf Mount Back Rail	1

Additional sizes are available (call for details)



new



STOCK DISPLAYS

Scoop Bins

Improve customer interaction and differentiate from competitors by adding bulk Scoop Bins into your retail environment. Bulk Scoop Bins provide customers the opportunity to pick and mix various products at their discretion.

Using product scoops attached to each bin, customers can fill up as much or as little product as they require. This reduces packaging waste and ensures the displayed product is consumed without waste.

Scoop Bins grab customer attention, are easy to use, and improve overall gross margins versus similar pre-packaged products.

- Why Scoop Bins are so effective:
- Allow customers to pick and choose merchandise
- Portion control - less waste
- Easy to use
- First in / first out - guarantees freshness
- BPA/EA-free

Item No.	Style	Dimensions	Capacity	Pack
4855014827	Scoop Bin w/ sugar tray	12" W x 13.6" H x 14.8" D	5.28 G (20 L)	1
4637129392	Scoop Bin w/ sugar tray	8" W x 13.6" H x 14.8" D	3.3 G (12.5 L)	1
4633988273	Scoop Bin w/o sugar tray	8" W x 13.6" H x 14.8" D	3.3 G (12.5 L)	1
4852374281	Scoop Bin w/ divider w/ sugar tray	12" W x 13.6" H x 14.8" D	5.28 G (20 L)	1
4630828548	Scoop Bin w/ divider w/o sugar tray	12" W x 13.6" H x 14.8" D	5.28 G (20 L)	1

BPA/EA FREE

Scoop Bin Specifications

BPA/EA
FREE

The angled floor of our Scoop Bins promotes automatic stock rotation to ensure product freshness and quality. Re-merchandising is done through the top which can be fully removed or just opened.

If mounted on crossbar, the Scoop Bin can be pulled out for easy refill without having to remove the bin from the fixture. The Scoop Bins are sealed and have hinged, dust-proof covers to protect merchandise from external contact.

- Scoop Bin can mount onto crossbar with brackets or onto shelf with cylindrical bumper buttons
- Available with or without divider
- Includes catch tray for easy removal of crumbs and sugar
- Use optional shutter to slow the flow and avoid accidental overfilling
- For long or otherwise cumbersome merchandise, we recommend replacing the scoop with Tongs (sold separately)
- Our Scoop Bins can be equipped with a perpendicular holder to support shelf talker or aisle sign to communicate to customers
- Transparent body; scoop and top lid black as standard
- Additional colors available on request for improved segmentation



Scoop Bin
(5.28 gallon)
4855014827

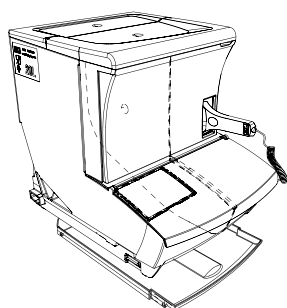

Scoop Bin with Divider
(5.28 gallon per side)
4852374281

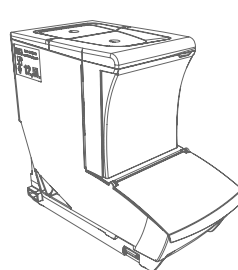

Scoop Bin
(3.3 gallon)
4633988273

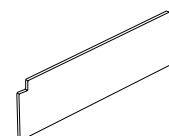

Shutter for Scoop Bin
without Divider
4856520795



Shutter for Scoop Bin
with Divider
4856166098

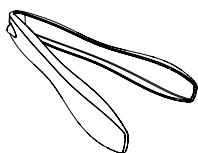

Scoop Tongs
4854994768

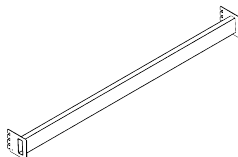

Crossbar
4639743773

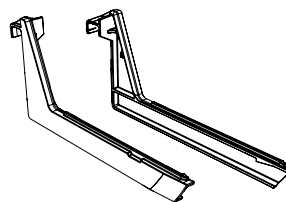

Mounting Brackets
4858644983

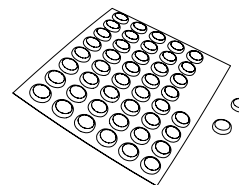

Cylindrical Bumper
8207511700

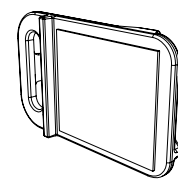

Label Holder
4854847331

Item No.	Style	Dimensions	Capacity	Pack
4856520795	Shutter for Bin w/out Divider	N/A	N/A	1
4856166098	Shutter for Bin with Divider	N/A	N/A	1
4854994768	Scoop Tongs	2.75" W x 1.25" H x 8" L	N/A	1
4639743773	Crossbar	48" W x 2.5" H	N/A	1
4858644983	Mounting Brackets	Left and Right	N/A	1 set
4854847331	Label Holder	4.1" W x 2.9" H	N/A	1



new



GoMix™ Pick & Mix Display

Improve customer interaction and differentiate from competitors with the GoMix™ Pick & Mix bulk merchandising display. Customers get a more interactive shopping experience that lets them select as much product as they want at their discretion. Retailers get the added benefit of first-in, first-out product rotation, reduced spoilage, and increased sales!

The GoMix™ Display is versatile and is easy to integrate into new or existing store planograms. It's a complete merchandising station with four shelves to display bins. GoMix™ features an assortment of scoop bins, bag holders, and other accessories which can be adapted to accommodate store needs. The base of the rack is equipped with a scrap collector to collect and hide spilled products.

- Bins pull out for easy refill, cleaning and planogram changes.
- Soft closing lid prevents lid from closing on consumers hands while shopping.
- Integrated sugar tray
- Externally placed label holder facilitates quick change of photo fronts/bin labels.
- Number of scoop and bag holders can be adapted to each store.
- Waterfall display for easy consumer access to each bin and maximum visual impact.
- Integrated scrap collector to maintain a fresh looking display. Pulls out for easy scrap removal.

Item No.	Product	Dimensions	Color
4369190008	GoMix Display	48" W x 75" H x 34" D	Orange
4369190009	GoMix Sign Holder	48" W x 15" H x 12" D	Orange
4369190010	GoMix Side Panel	31" W x 86" H	Orange
4369190011	GoMix Scoop Holder	24" W x 3" H x 4" D	Transparent
4369190012	GoMix Scoop	2.5" W x 5" H	Transparent



Visi-Bin™

siffron's designed Visi-Bins maximize the appeal of product merchandising. There are many styles, shapes, sizes and applications to choose from to create the look and presentation that best suits your product.

Visi-Bins can be used with all standard slatwall, pegboard and 3" grid displays. The pegboard adapter is designed to maximize the spacing of the bins across a three or four foot wide section. The grid adapter allows Visi-Bins to be merchandised back-to-back on a single grid panel to maximize display space.

- Combine sizes to create an attractive, tiered display
- Available in 7.5", 9.5" and 11.5" depths
- Durable molded construction holds up to 5 pounds of product
- Angled opening allows for easy access to product
- Utilize our Universal Mount Price Tag Holder for an attractive and easy way to label bins

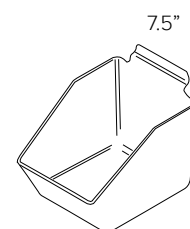

7400894125

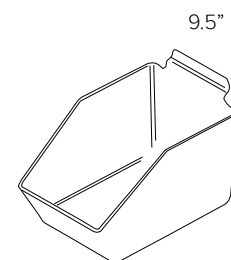

7401878839

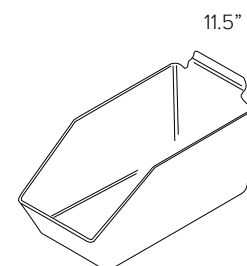

7407881267

Item No.	Ref. No.	Dimensions	Finish	Pack
7400894125	RPDMP-65575	6" W X 5.5" H X 7.5" D	Clear	10
7401878839	RPDMP-65595	6" W X 5.5" H X 9.5" D	Clear	10
7407881267	RPDMP-655115	6" W X 5.5" H X 11.5" D	Clear	10

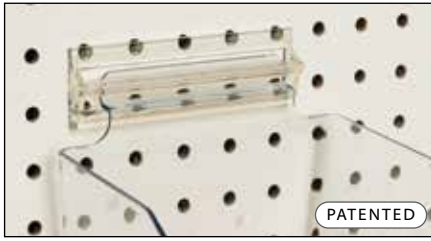

Visi-Bin™ Peg Board Adaptor

- Adaptor allows Visi-Bins to be mounted onto standard 1" pegboard.
- Notched back allows bin to extend over upright.
- Eight bins fit across a 4' section.
- Clear finish for attractive appearance.

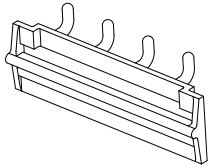

Item No.	Ref. No.	Dimensions	Finish	Pack
7402366019	RPDMP-SBACK	4.625" W x 1.375" H x 0.5" D	Clear	10

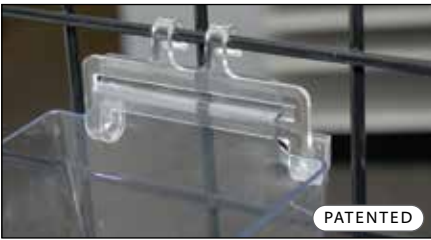

Visi-Bin™ Grid Panel Adaptor

- Adaptor allows Visi-Bins to be hung on grid panels.
- Unique design allows for Visi-Bins to be hung back-to-back on the grid panel.
- Clear finish for attractive appearance.

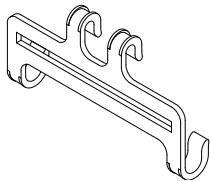

Item No.	Ref. No.	Dimensions	Finish	Pack
7400191479	RPDMP-GBACK	4.75" W x 2.56" H x .5" D	Clear	10



Visi-Bin™ Cup

- Attractive, clear design works with many products.
- Durable Hybrid Styrene construction for greater strength.
- Two pegs for use with 1" pegboard and slatwall.

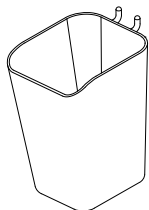

Item No.	Ref. No.	Dimensions	Finish	Pack
7409469077	RPDMP-404560	4" W x 6" H x 4.5" D	Clear	5

Visi-Bin™ Tray

- Attractive, clear design works with many products.
- Durable Hybrid Styrene construction for greater strength.
- Four pegs for use with 1" pegboard and slatwall.

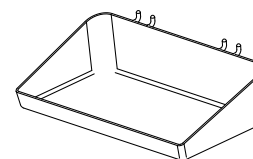

Item No.	Ref. No.	Dimensions	Finish	Pack
7405159272	RPDMP-127032	12" W x 3" H x 6.5"D	Clear	5

Visi-Bin™ Double-Wide

- Attractive, clear design works with many products.
- Durable Hybrid Styrene construction for greater strength.
- Use in slatwall or in pegboard with adaptor.

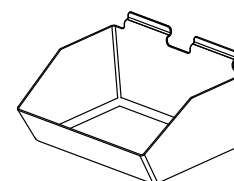

Item No.	Ref. No.	Dimensions	Finish	Pack
7401612228	RPDMP-129555	12" W x 5.5" H x 9.5" D	Clear	5

Visi-Bin™ Arc

- Arc front of Visi-Bin creates unique view of bulk merchandise.
- Designed with a drop down lip in order to access products easier.
- Clear construction presents full view of merchandise.
- .09" thick wall offers a more durable bin that can carry a heavier load.
- Attaches to standard slatwall and to standard pegboard with the pegboard adaptor.



Item No.	Ref. No.	Dimensions	Finish	Pack
7403634992	RPDMP-120606-AR	12" W x 6"H x 6"D	Clear	10

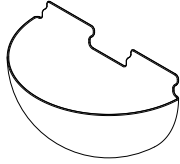

Visi-Bin™ Quarter Ball

- Bowl shape of the Visi-Bin creates unique view of bulk merchandise.
- Clear construction presents full view of merchandise.
- .09" thick wall offers a more durable bin that can carry a heavier load.
- Attaches to standard slatwall and to standard pegboard with the pegboard adaptor.

Item No.	Ref. No.	Dimensions	Finish	Pack
7409742347	RPDMP-120606-QB	12" W x 6"H x 6"D	Clear	10

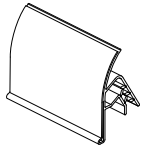

Visi-Bin™ Label Holder

- Label Holder designed to fit on Visi-Bin front edge.
- Stock in 2" length.
- Custom lengths available. Call for details.

Item No.	Ref. No.	Dimensions	Finish	Pack
4404144886	RPDMP-L21	2" L x 1.25" H	Clear	100

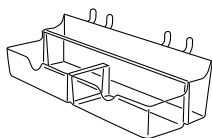

Visi-Bin™ Gift Card Tray

- Three trays, two 3.5" card trays and one 7.25" envelope tray.
- Attractive, clear design works with many products.
- Durable Hybrid Styrene construction for greater strength.
- Four pegs for use with 1" pegboard and slatwall.

Item No.	Ref. No.	Dimensions	Finish	Pack
7402351736	RGCT-0001	7.625" W x 2" H x 2.5" D	Clear	4

Visi-Bin™ Basket for Fastrack® & 1" Crossbar

- Visi-Bins™ for 1" Crossbar and Fastracks® are designed to allow the bin to be easily installed onto the 1" grid of a Fastrack® or onto a 1" crossbar.
- Unique design of mounting clips allow for easy installation on Fastracks® while keeping the Visi-Bin™ from being knocked off.
- Mounting clips provide a snug, secure fit on 1" crossbar.
- Visi-Bin™ Baskets feature key-hole slots for insertion of dividers for product separation and clean display appearance.
- Dividers to organize the merchandise that is displayed in basket insert into keyhole slots.

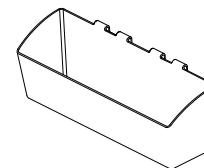

740531264



7401410112

Item No.	Ref. No.	Dimensions	Finish	Pack
7405312643	RPDMP-140405-FR	14" W X 5" H X 4" D	Clear	5
7401410112	RPDMP-FR-DIV	4" W X 5" H	Clear	10

Visi-Bin™ Peg Back Tier Gift Card Tray

- 3-Tier and 4-Tier trays each have 25 card deep pockets, and function as stand-alone, counter top displays, or can be placed on pegboard using the RGCT-PEG adaptor.
- Works with the RGCT-PEG adaptor.

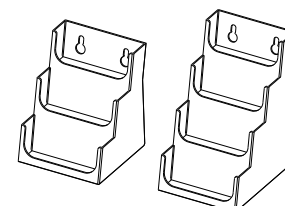
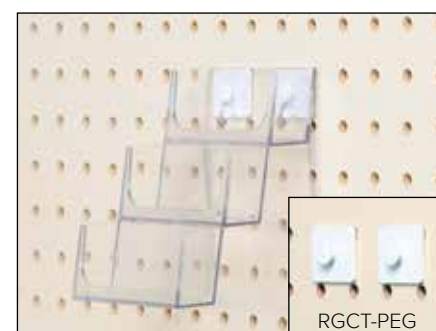

7400372470

7407535332

Item No.	Ref. No.	Dimensions	Finish	Pack
Visi-Bin™ Peg Back Tier Gift Card Tray				
7400372470	RGCT-0003	4.5" H x 3.62" W x 3.67" D	Clear	4
7407535332	RGCT-0004	6" H x 3.62" W x 4.875" D	Clear	4
Visi-Bin™ Peg Adapter				
7409623257	RGCT-PEG	1.45" H x 1.25" W x 0.785" D	White	20



Fastrack®

Fixed Rail Design

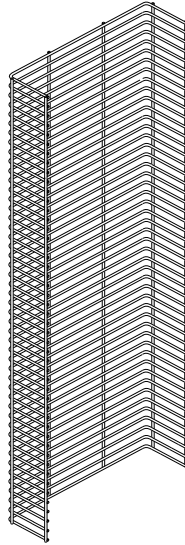

Fixed Rail

- 48" H x 14.5" W
- 4.5" D Side Panels
- 1" spaced, .149" dia. wire grid
- Available in silver or almond powder coat
- Custom powder coat colors available

Fixed Rail Design with Welded Brackets

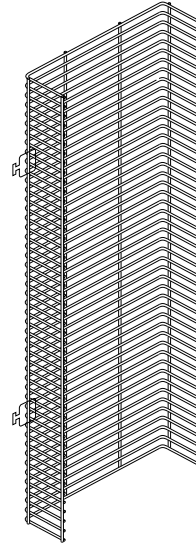

Fixed Rail with Welded Brackets

- 48" H x 14.5" W
- 4.5" D Side Panels
- 1" spaced, .149" dia. wire grid
- Universal mounting brackets pre-welded
- Available in silver or almond powder coat
- Custom powder coat colors available

Folding Rail Design

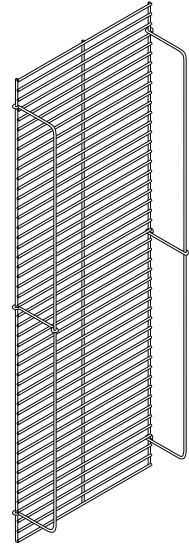

Folding Rail

- 48" H x 14.5" W
- 1" spaced, .149" dia. wire grid
- 4.5" foldable side rails
- Available in silver powder coat
- Custom powder coat colors available

STOCK DISPLAYS



Custom Powder Coated Colors Available

Item No.	Ref. No.	Dimensions	Finish	Pack
Fixed Rail Design				
8301009823	R40-III-2BX	48" H x 4.5" D x 14.5" W	Silver	2
8301263612	R40-III-4BX	48" H x 4.5" D x 14.5" W	Silver	4
8304874545	R40-III-4BXA	48" H x 4.5" D x 14.5" W	Almond	4
Fixed Rail Design with Welded Brackets				
8309004192	R40IIIWGD-4BX	48" H x 4.5" D x 14.5" W	Silver	4
8309759809	R40IIIWGD-4BXA	48" H x 4.5" D x 14.5" W	Almond	4

Fastrack® Universal Mounting Kits

- Mounts the Fastrack® to most gondola uprights.
- Patented design stabilizes any Fastrack® to reduce movement.
- Kit includes: Two universal brackets, two control clamps, two bolt, and two wing nuts in a polybag.

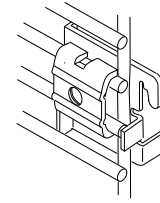

Item No.	Ref. No.	Dimensions	Finish	Pack
8307154737	R40-GD-MTG	2" H x 1" D x 1.875" W	Zinc	1 Kit

Fastrack® J-Mount Kits

- Mounts the Fastrack® to most perforated shelving
- Easily installed and removed
- Kit includes 2 J-mounts, 2 bolts, and 2 wing nuts in a polybag.

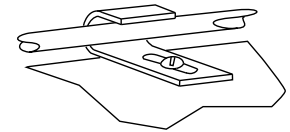

Item No.	Ref. No.	Dimensions	Finish	Pack
8309277392	R40-JMK	.5" H x 1.75" D x 1" W	Zinc	1 Kit

Fastrack® Impulse Bracket

- Holds impulse racks in place on the side of retail gondolas.
- Attaches to .25" shelf perforations.
- 12 gauge steel is used for supporting heavy racks.

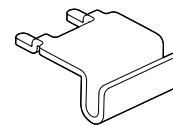

STOCK DISPLAYS

Item No.	Ref. No.	Dimensions	Finish	Pack
8306377307	R16-ZSIR-BKT	1.5" x .75" x 1.5"	Galv.	2

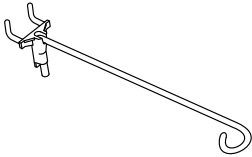

Fastrack® Support Arms

- Secures Fastrack® to prevent swaying.
- Two-piece design includes plastic back for easy installation.
- R40-9-SUPRT fits R40-III rack.

Item No.	Ref. No.	Dimensions	Finish	Pack
8309318528	R40-9-SUPRT	9" L x .224" Dia.	Galv.	20

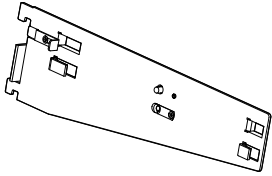

Fastrack® Universal Mounting Arm

- Heavy-duty mounting arm for hanging Fastracks® on gondola uprights.
- Works with most uprights.
- Reinforced to reduce sway of Fastrack® when mounted.
- Kit includes two brackets (left/right).

Item No.	Ref. No.	Dimensions	Finish	Pack
8303964714	R40-FSTRKBRKT	.73" x 3.84"H x 14.72"D	Galv.	10 Kits



Now available with clips

Fastrack® Power Bar

- Allows you to attach corrugated displays to most perforated shelving
- Available Bar only or Bar with two integrated Fastrack® Clips
- Two sizes available with adjustable arms to fit shelf perforations up to 14" apart or 17.5" apart
- .177" diameter steel wire

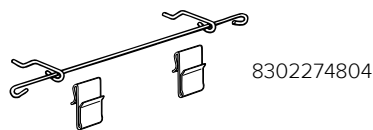

8302274804

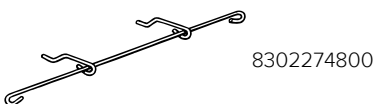

8302274800

Item No.	Ref. No.	Dimensions	Fits	Pack
Fastrack® Power Bar				
8302274800	-	15.5" L	up to 14"	1
8302274810	-	19.25" L	up to 17.5"	1
Fastrack® Power Bar with Clips				
8302274804	-	15.5" L	up to 14"	1

Additional sizes can be made to order (minimum quantities apply.)

Fastrack® Hook with Metal Scanning Plate

- Designed to fit most 1" wire grid Fastracks®.
- Hooks are designed to maximize the Fastrack® space.
- Hooks do not hang past the Fastrack® into the shopping aisle.
- Curl back design offers a friction fit.
- Fits on 3/6" x 1" cross bars and 1" grid wire.

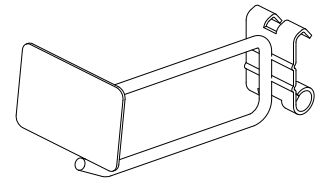

Item No.	Ref. No.	Dimensions	Finish	Pack
7144690493	RCCS325-186UP2	3.25" D x .186" Dia	Galv.	100

Fastrack® Hook with Fast-Flip™

- Designed to fit most 1" wire grid Fastracks®.
- Hooks are designed to maximize the Fastrack® space.
- Uses Fast-Flip™ Label Holder only. Label holders sold separately.
- Hooks do not hang past the Fastrack® into the shopping aisle.
- Curl back design offers a friction fit.
- Fits on 3/6" x 1" cross bars and 1" grid wire.

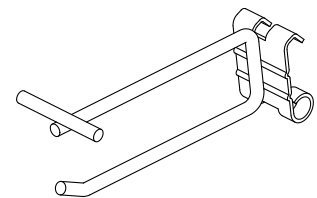

Item No.	Ref. No.	Dimensions	Finish	Pack
7146040179	RCCS325-186USU	3.25" D x .186" Dia	Galv.	100

Fastrack® Curlback Crossbar & Grid Hook

- All crossbar hooks are available with the fast-fitting metal curl back.
- Fits 3/16" X 1" crossbars, or 1" wire grid.
- Custom powder coat colors available.

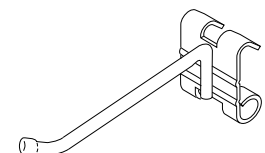

Item No.	Ref. No.	Dimensions	Finish	Pack
7140891458	RCBC-4-149	4" L x .149" Dia.	Galv.	100

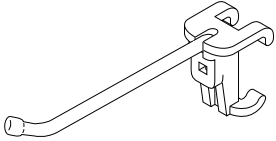

Fastback® Crossbar & Grid Stem Hooks

- 4" length hook designed specifically to work on end-cap merchandisers, including siffron's Fastracks®, keeping hook from protruding past rails, increasing safety.
- Plastic back will not scratch powder coated surfaces.

Item No.	Ref. No.	Dimensions	Finish	Pack
7141967902	R24-4	4" L x .149" Dia.	Galv.	200
7147700805	R24-4-20	4" L x .149" Dia.	Galv.	20

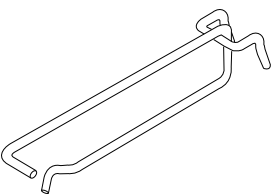

Fastrack® All-Wire Scanning Hooks

- Unique, all-in-one design prevents accidental dislodging from Fastrack®.
- Label holders sold separately. Metal plates optional, call for pricing.
- Custom powder coat colors available.

Item No.	Ref. No.	Dimensions	Finish	Pack
7149965782	R46-4-186	4" L x 186" Dia.	Galv.	100

Fastrack® Baskets

- Clips on any Fastrack® or standard crossbar.
- Creates a bulk display for any uncarded products.
- Custom powder coat colors available.
- Custom Fastracks® - Call us today and find out how we can customize a display for you!

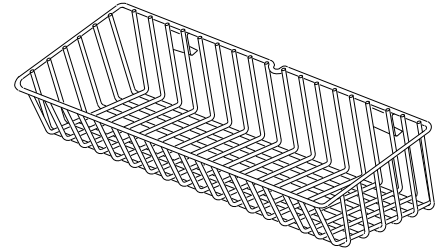

Item No.	Ref. No.	Dimensions	Finish	Pack
8303291027	R40-BASKET	13.25" W x 4.75" H x 4.25" D	Chrome	20

Fastrack® Shelves

- Clips on any Fastrack® or standard crossbar.
- Holds boxes, books, video tapes, or tube products.
- Custom powder coat colors available.
- Custom Fastracks® - Call us today and find out how we can customize a display for you!

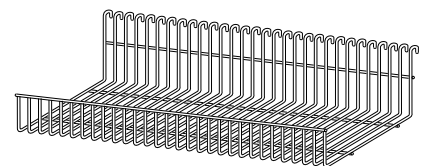

Item No.	Ref. No.	Dimensions	Finish	Pack
8301964223	R40-SHELF	12.8" W x 5.25" H x 4.75" D	Chrome	20

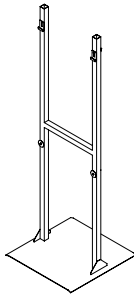

Fastrack® Center Mount Platform Base

- Turn any Fastrack® into a free-standing display.
- Its small footprint allows it to be placed conveniently throughout the store.
- Use two Fastracks® to create a two sided display.
- Can be used with one or two Fastracks® (Fastrack® sold separately).

Item No.	Ref. No.	Dimensions	Finish	Pack
8307408012	R40-CNTR-PB	48"H x 16" W x 16" D	Silver	1

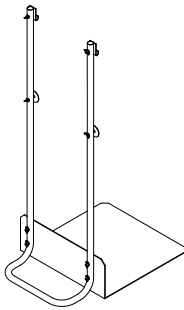

Fastrack® Platform Base

- Works with both styles of Fastrack® (Fastrack® sold separately).
- Slips under cut cases like a wedge base sign holder, for an aisle end freestanding display.
- Reverse the base and it becomes a freestanding display.
- Platform base includes: tube upright, metal base, and mounting hardware.

Item No.	Ref. No.	Dimensions	Finish	Pack
8309768187	R40-PLATFORM	36" H X 14" D X 14" W	Black	2

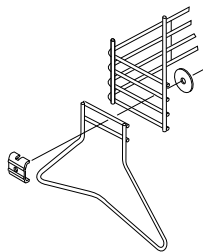
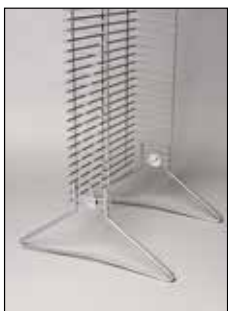

Fastrack® III Wire Leg Set

- Works with Fixed Rail Fastbacks® (Fastrack® sold separately).
- Sturdy leg set allows placement of the Fastrack® III anywhere.
- Creates a low cost, freestanding product display.
- Leg set includes: two leg bases and mounting hardware.
- .312" diameter.

Item No.	Ref. No.	Dimensions	Finish	Pack
8305222306	R40-LEGS	8" H X 16.5" D X .312 Dia.	Silver	1 Set

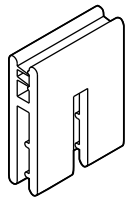

8312722900

Fastrack® Clip-On Sign Holder

- Easily clips on to Fastrack to hold carded signs.
- Split design allows for unrestricted use.



8301384396

Fastrack® Header Clip

- A low cost card holder for any Fastrack.
- Also works on crossbar.
- Custom powder coat colors available.

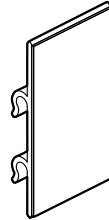

8300904000

Fastrack® Side Panel Clip

- Low-cost solution to add graphic side panels to a Fastrack.
- Clear clips with adhesive pad for quick installation.
- Custom sizes available. Call for details.

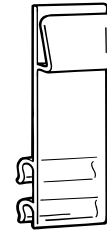

8302043300

Fastrack® Wire Grid Sign Holder

- Holds sign above wire fixtures
- Displays signs in flush position
- Fits most Power Wing fixtures up to .188" diameter
- Holds up to .125" thick sign
- Clear butyrate

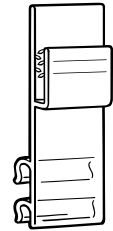

8317095900

Fastrack® SuperGrip® Wire Grid Sign Holder

- SuperGrip® brand technology securely holds signs
- Displays sign in flush position
- Fits most Power Wing fixtures up to .188" diameter
- Holds up to .125" thick sign
- Clear PVC

Item No.	Ref. No.	Dimensions	Finish	Pack
Fastrack® Clip-On Sign Holder				
8312722900	R-CSH	1.75" H x 1.3125" W	Clear	100
Fastrack® Header Clip				
8301384396	R40-HC	2.25" H x 1" Loop Dia.	Galv.	100
Fastrack® Side Panel Clip				
8300904000	R-FRSH-125	1.25"W x 2.275"H	Clear	20
Fastrack® Wire Grid Sign Holder				
8302043300	-	3.75" H x 1.25" L	Clear	1
Fastrack® SuperGrip® Wire Grid Sign Holder				
8317095900	RFG2-019-125	3.875" H x 1.25" L	Clear	1

Additional lengths and colors can be made to order (minimum quantities apply.)



STOCK DISPLAYS

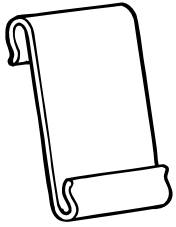

8307625300

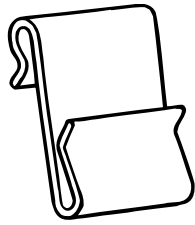

8301867600

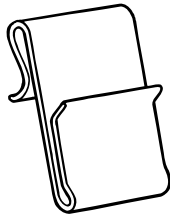

8307603700

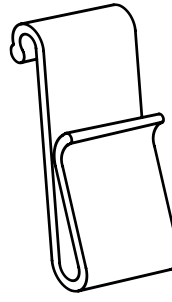

8301463094

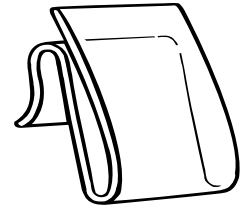

8302092203

Fastrack® Clip WC-1

- Holds corrugated displays on Wire Fastrack®
- Fits up to .250" diameter wire
- Holds .125" B-Flute corrugated
- White polypropylene

Fastrack® Clip WC-3

- Holds corrugated displays on Wire Fastrack®
- More secure grip on corrugated
- Fits up to .250" diameter wire
- Holds .125" B-Flute corrugated
- White polypropylene

Fastrack® Clip WC-6

- Holds corrugated displays on Wire Fastrack®
- More secure grip on corrugated
- 1.25" L; Designed for easiest installation
- Fits up to .250" diameter wire
- Holds .125" B-Flute corrugated
- White polypropylene

Fastrack® Clip WC-6

- Holds corrugated displays on Wire Fastrack®
- More secure grip on corrugated
- 2" L
- Fits up to .250" diameter wire
- Holds .125" B-Flute corrugated
- White polypropylene

Fastrack® Clip WC-9

- Holds corrugated displays on Wire Fastrack®
- Fits up to .250" diameter wire
- Holds .125" B-Flute corrugated and .25" A-Flute corrugated
- Natural polypropylene

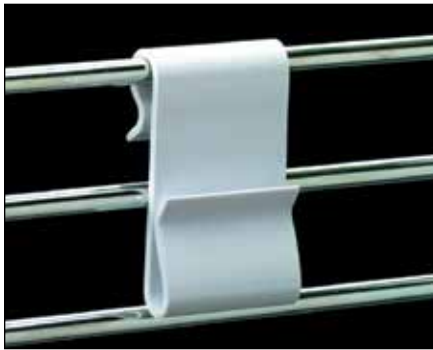

Item No.	Ref. No.	Dimensions	Finish	Pack
Fastrack® Clip WC-1				
8307625300	R16-125-PWC	1" L x 2" H	White	1
Fastrack® Clip WC-3				
8301867600	R16-PWC-HD2	1" L x 1.75" H	White	1
Fastrack® Clip WC-6				
8307603700	R16-PWC-HD3	1.25" L x 2.25" H	White	1
8301463094	R16-PWC-HD	1" W x 2" L x .625" D	White	1000
Fastrack® Clip WC-9				
8302092203	-	1" L x 2" H	Natural	1
8302092201	R16-PWC-SL15	1.5" L x 2" H	Natural	1

Additional colors can be made to order (minimum quantities apply.)



Fastrack® Clip for Square Edge

- Holds corrugated displays on square-edged fixtures
- Fits up to 0.94" thick fixtures
- Holds up to .9375" corrugated
- 1" L x 2.80" H
- White ABS

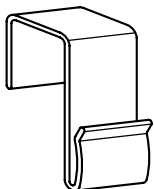

Item No.	Ref. No.	Dimensions	Finish	Pack
8307711301	-	1" L x 2.80" H	White	1

Additional colors can be made to order (minimum quantities apply.)

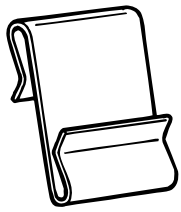

8307842300

Fastrack® Metal Clip WC-2

- Zinc-plated clip holds corrugated display on Wire Fastrack®
- Fits up to .219" diameter wire
- Holds up to .25" A-Flute corrugated
- Zinc-plated steel

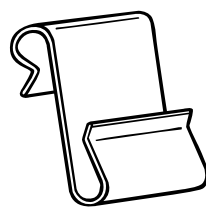

8300323700

Fastrack® Metal Clip Large WCM-3

- Zinc-plated clip holds corrugated display on Wire Fastrack®
- Fits up to .375" diameter wire
- Holds up to .3125" corrugated
- Zinc-plated steel

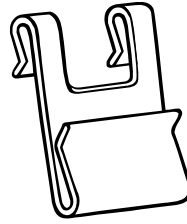

8305630200

Fastrack® Warehouse Clip

- Holds corrugated displays securely in retail warehouse environments
- Fits most standard warehouse uprights
- Holds up to .125" B-Flute corrugated
- White PVC

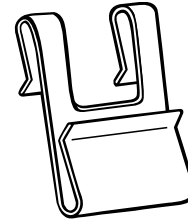

8304960000

Fastrack® Warehouse Clip/Metal

- Zinc-plated clip holds displays securely in retail warehouse environments
- Fits most standard warehouse uprights
- Holds up to .125" B-Flute corrugated
- Zinc-plated steel

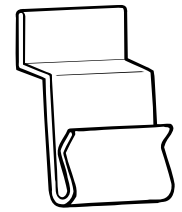

8307993600

Fastrack® Clip for Slatwall WC-10

- Holds corrugated displays flush to slatwall
- Upper lip fits most standard slatwall
- Holds .125" B-Flute corrugated
- White PVC

Item No.	Ref. No.	Dimensions	Finish	Pack
Fastrack® Metal Clip WCM-2				
8307842300	R16-PWC-LW1	1" L x 175" H	Silver	1
Fastrack® Metal Clip, Large WCM-3				
8300323700	R16-PWC-SW1	1" L x 175" H	Silver	1
Fastrack® Warehouse Clip				
8305630200	R16-PWC-WP1	1.5" L x 2.375" H	White	1
Fastrack® Warehouse Clip, Metal				
8304960000	R16-PWC-MW1	1.5" L x 2.375" H	Silver	1
Fastrack® Clip for Slatwall WC-10				
8307993600	R16-PWC-PSW1	1" L x 2" H	White	1

Additional lengths and colors can be made to order (minimum quantities apply.)

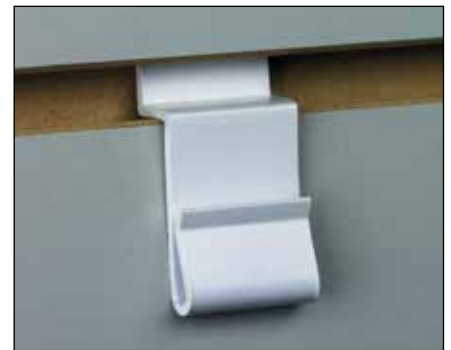

Fastrack® Clip for Pegboard/Slatwall WC-12

- Holds corrugated displays flush to most standard pegboard and slatwall
- Prongs fit pegboard with holes 1" on center
- Holds up to .25" A-Flute corrugated
- White ABS

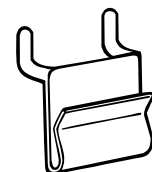

Item No.	Ref. No.	Dimensions	Finish	Pack
8301105200	RFLSH-MNT	1.25" L x 1.25" H	White	1

Additional colors can be made to order (minimum quantities apply.)

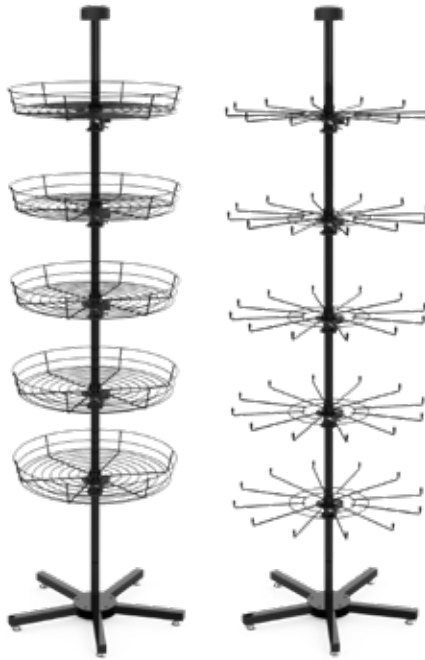
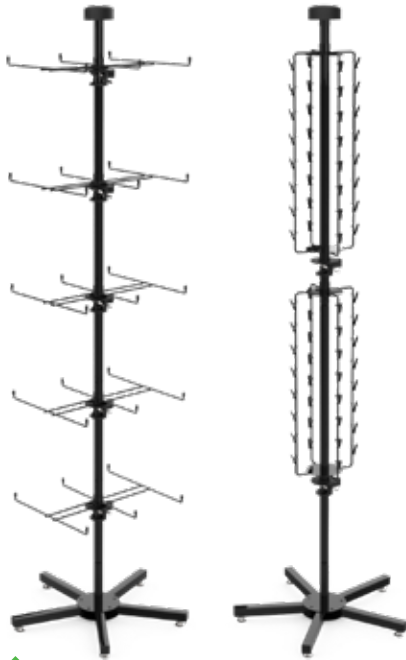

new



Pole Star® Spinner Display

The Pole Star® Spinner Display features a streamlined design to reduce setup and install times. Set up a display quickly and easily. The patent pending rotor stop ensures display racks are easily adjustable but maintain a firm hold using minimal effort. Various merchandising options are available to hold different product packaging types and sizes.

The Pole Star® Spinner Displays are perfect for boosting category sales in impulse areas near checkout lanes and throughout convenience stores, with products such as gift apparel, snacks, candy, toys and more..

- Simplified design for easy installation and manipulation
- Patent-pending rotor stop design allows for easy adjustability with a strong hold using minimal effort
- Rotors spin for 360-degree product access
- Various rotor styles are available
- Custom styles available.
- Stock color is black; custom colors are available.
- Clipper display includes 32 clips per fixture
- Minimum quantity orders will apply for all custom options

Item No.	Style	Dimensions	Finish
7700036283	Basket Rotor Display – 5-tier	20" W x 67" H	Black
7700036281	6-Hook Display – 5-tier	20" W x 67" H	Black
7700036282	Radial Hook Display – 5-tier	20" W x 67" H	Black
7700036280	Clipper Display – 2-tier	20" W x 67" H	Black



Pole Star® 4-Way Sign Topper

- Designed to hold thicker signs - up to 3/16" thick foamcore.
- Unique design holds two or four-way sign.
- Fits both 1" and 1-1/2" poles.
- Custom sign and header printing available.

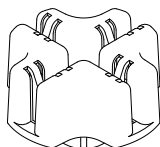

Item No.	Ref. No.	Dimensions	Finish	Pack
7509641825	RPS-4P-TOPK	2" H x 3.5" D x 3.5" W	Black	10
7509270666	RPS-4P-TOPW	2" H x 3.5" D x 3.5" W	White	10



Pole Star® 2-Way Sign Topper

- Designed to hold signs as thick as 50 point chip board.
- Fits both 1" and 1-1/2" poles.
- Custom sign and header printing available.

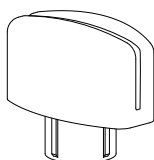

Item No.	Ref. No.	Dimensions	Finish	Pack
7502849109	RPS-TOP1-K	2" H x 3.5" D x 2" W	Black	10

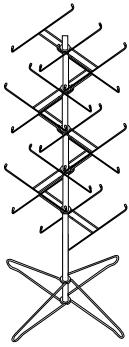

7506389187

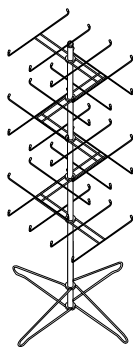

7509126753

All-Wire Spinner Display

- Adjustable rotors for custom spacing.
- Available in six or eight prong configuration.
- Complete with sign holder.
- Chrome finish.
- Custom styles available.
- Custom sign and header printing available.
- RSR-5-6P: 7.5" between hooks. Hook length is 6". Collapsible base has 25" dia.
- RSR-5-8P: 5" between hooks. Hook length is 6". Collapsible base has 25" dia.

Item No.	Ref. No.	Dimensions	Finish	Pack
7506389187	RSR-5-6P	63" H, 1" Pole Dia., 6 Prong	Chrome	1
7509126753	RSR-5-8P	63" H, 1" Pole Dia., 8 Prong	Chrome	1

Bowl Tower Display

Clear bowls for complete view of impulse products from all angles. Clear bowl design attracts buyers and allow customers to view product through bin.

Features

- Quick and easy assembly with no hardware required.
- Heavy 11 gauge base keeps the display from tipping.
- Holds 7" x 5.5" signs in a clear sign holder above the product.
- Great for advertising sales, pricing, or products.
- Powder coated: Silver.
- Bowls: Clear Polycarbonate.
- Sign holder: Clear PETG.

Dimensions

- Sign holder: 7" W x 5.5" H
- Tower including sign holder: Approx. 64.25" H
- Bowls: 12" Dia. X 6" H
- Gap in-between bowls: 3.9"
- Base: 16" Dia. X 11 gauge

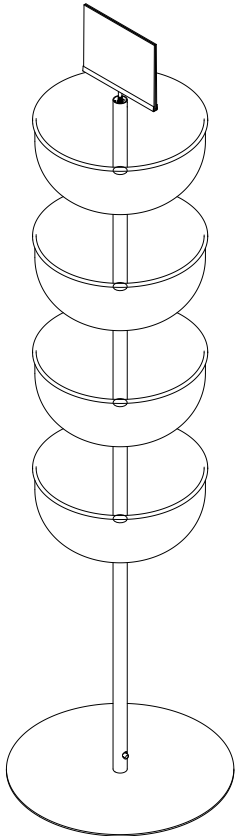

STOCK DISPLAYS

Item No.	Ref. No.	Dimensions	Finish	Pack
7401957021	R-IBT-4	64.25" H, 12"D x 6"H Bowls	Clear	1



Clear Bowl Display

Clear Bowl Displays can promote a multitude of different products. Most buying decisions are made at a point of sale. When clearly displayed, product has a greater chance of being selected. The attractive, transparent design showcases impulse or cross merchandising products rather than obscures them. It also easily alerts retailers when display bowls need to be restocked. Clear Bowl Displays are now available with dividers to organize the bowls for multi-purpose use. Dividers come in half and quarter inserts.

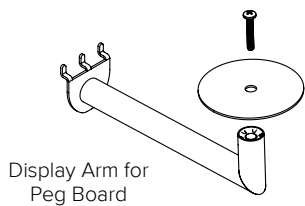

Display Arm for Peg Board

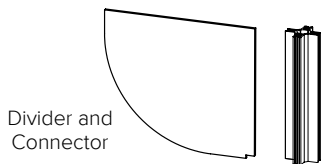

Divider and Connector

- Minimal mounting hardware makes it easy to setup
- Clear display helps keep product visible
- Simple design
- Ideal for bulk items
- Installs into pegboard via mounting arm or display stanchions
- Each divider kit includes four quarter dividers and one divider connector
- - Connect two quarter dividers to divide bowl into two sections
- - Connect four quarter dividers to divider bowl into four sections
- - Kits sold in packs of ten only
- Each Flag Mount for Gondola Upright Kit includes one mount and one sign frame with stem

Item No.	Ref. No.	Style	Dims	Finish	Pack
2208639817	R16-IMBOWL	Display Bowl	13" Dia	Clear	1
7409880746	R-IBH-12P09	Display Arm for Peg Board	9" L	White	1
7908168896	R-IBD4-12	Clear Bowl Divider Kits	6" W	Clear	10 Kits

H-Grid Display

- Great foundation for creating your own custom arrangement with a variety of hooks, shelves and baskets.
- Durable H-Grid display comes complete with H Base, four 5' H x 2' W grid or slot grid panels, and connectors.
- Made from sturdy .250" diameter wire.
- Available in standard 3" grid (GRD) or Slot grid (SGRD).



Item No.	Ref. No.	Dimensions	Finish	Pack
9925511212	R40-H-GRD-K	2' W x 4" L x 5' H	Black	1

Tri-Grid Tower Display

- Create your own mobile display with a variety of hooks, shelves and baskets.
- Durable Tower display comes complete with triangle base, three 6' H x 2' W grid or slot grid panels, and connectors.
- Made from sturdy .250" diameter wire.
- Available in standard 3" grid (GRD) or Slot grid (SGRD).
- Includes three heavy duty casters.

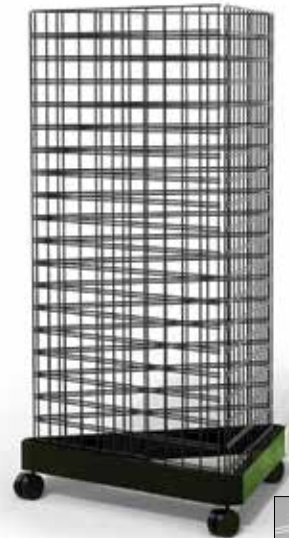

Item No.	Ref. No.	Dimensions	Finish	Pack
7600751883	R40-T-GRD-K	20.75" W x 2' L x 6' H	Black	1

4-Way Grid Display

- 4-way display is a mobile and compact design to maximize merchandise space within a small foot print.
- Durable 4-way display comes complete with 4-way base, four 5' H x 2' W grid or slot grid panels, and connectors.
- Made from sturdy .250" diameter wire.
- Available in standard 3" grid (GRD) or Slot grid (SGRD).
- Includes four heavy duty casters.



Item No.	Ref. No.	Dimensions	Finish	Pack
7603091137	R40-4-GRD-K	3' W x 3' L x 5' H	Black	1

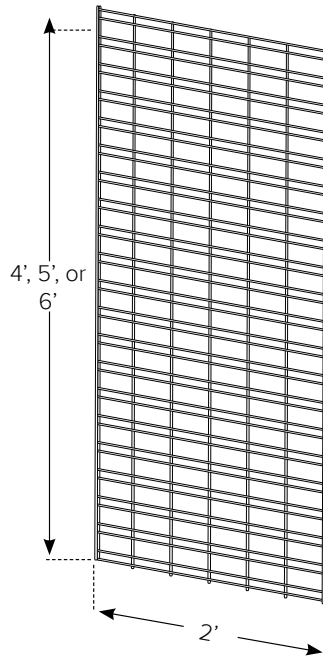

Slat Grid Panels

7601374715

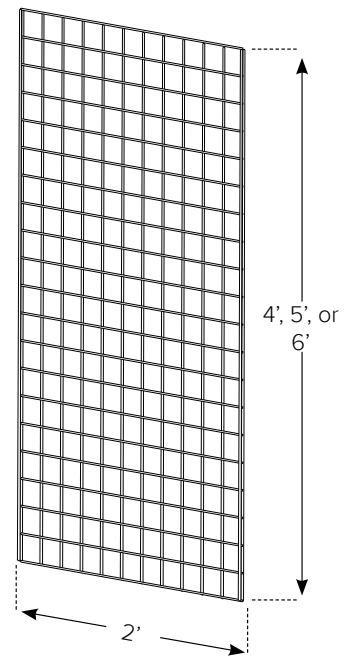

3" Grid Panels

9925511201
7605676324

Grid Panels

- Available in Slat Grid or 3" Grid Styles with black finish
- Standard width of 24" with available heights of 4', 5', and 6'.
- Custom powder coat colors are available. Call for details.

Item No.	Ref. No.	Dimensions	Finish	Pack
3" Grid Panels				
9925511201	R40-GDE-25K	2' W x 5' H	Black	3
7605676324	R40-GDE-26K	2' W x 6' H	Black	3
Slat Grid Panels				
7601374715	R40-SGDE-26K	2' W x 6' H	Black	3

Additional sizes can be made to order (minimum quantities apply.)

STOCK DISPLAYS



Heavy Duty

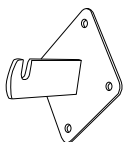

7609931107

Grid Wall Mount Brackets

- Heavy Duty version features a forged back plate for extra support.
- Minimum of four brackets per grid are required.
- Attractive and durable chrome finish.

Item No.	Ref. No.	Dimensions	Finish	Pack
7609931107	R40-HDWMB	3" W x 3.75" H x 3" D	Chrome	10

Grid Display Accessories

Scanning Grid Hook

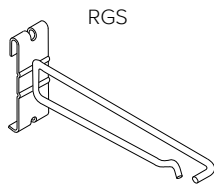

- Works on 2" and 3" grids.
- Notched back plate fits over center wires.

Single Stem Grid Hook

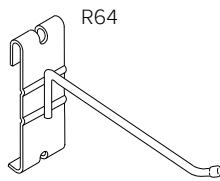

- Works on 2" and 3" grids.
- Notched back plate fits over center wires.

Scanning Slatwall Hook

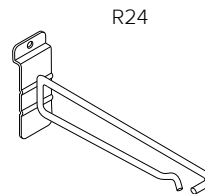

- Designed to fit all major brands of slatwall and slat grid.

Waterfall Grid Hook

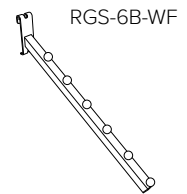

- Fits 2" to 3" grids.
- Six welded ball stops for hanging merchandise.

12x6 Basket

7702633884

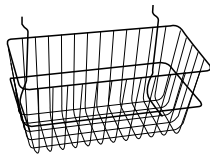

- Unique "locking" mechanism secures baskets to 3" grid panels.
- 12" L x 6" W x 6" H Basket.

12x12 Basket

7700852299



- Unique "locking" mechanism secures baskets to 3" grid panels.
- 12" L x 12" W x 8" H Basket.

Triangle Grid Base

7608977541

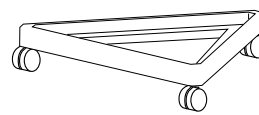

- Rugged steel construction for durability and support.
- Designed for double wire construction grids.
- Base comes complete with hardware, including casters.
- Available in white. Call for details.

Grid Legs

7604115793

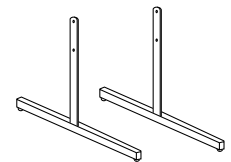

- Designed to fit all major brands of slatwall and slat grid.
- Large back plate for extra support.
- Sold in pairs. Includes hardware.
- Available in black or white.

Item No.	Ref. No.	Dimensions	Finish	Pack
Scanning Grid Hooks				
7143418854	RGS-6-K	6" L x .212" Dia.	Black	100
7144691043	RGS-8-K	8" L x .212" Dia.	Black	100
7141359699	RGS-10-K	10" L x .212" Dia.	Black	100
Single Stem Grid Hooks				
7146471055	R64-6-224-K	6" L x .224" Dia.	Black	100
7141747738	R64-8-224K	8" L x .224" Dia.	Black	100
Scanning Slatwall Hooks				
7101637884	R24-6-SWK	6" L x .212" Dia.	Black	100
7106466803	R24-8-SWK	8" L x .212" Dia.	Black	100
7107243832	R24-10-SWK	10" L x .212" Dia.	Black	100
Waterfall Grid Hook				
7171136495	RGS-6B-WF	16" x .75"	Chrome	20
Baskets				
7702633884	R40BSKE126K	12" L x 6" W x 6" H	Black	6
7700852299	R40BSKE1212K	12" L x 12" W x 8" H	Black	6
7608977541	R40-BASTE-K	21" W x 2' L	Black	1
9925511204	-	1.5" Dia	Black	1
9925511205	-	24.188" L x 2.375" H	Black	1

Additional sizes can be made to order (minimum quantities apply.)



9925511204



9925511205



7601586883

Grid Connectors

- Connects grid panels edge to edge.
- Durable chrome finish.

Heavy Duty Connector

- Cast metal clamp connects grid panels edge to edge.
- Durable chrome finish.



9925511206

Item No.	Ref. No.	Dimensions	Finish	Pack
7601586883	R40-HDJC	1" L x .5" W x .625" H	Chrome	10
9925511206	-	1.234" L x .825" W	Black	50

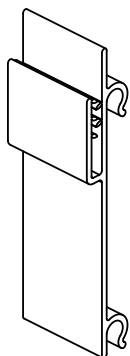
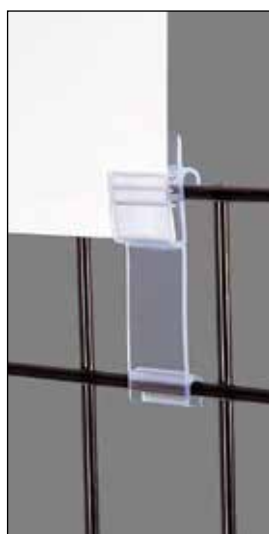

Grid Sign Holder

- Designed to fit on 3" grid panels and slat grid.
- Holds rigid signs on grid panels.
- SuperGrip® style fingers grip signs up to .125" thick.

Item No.	Ref. No.	Dimensions	Finish	Pack
1856075053	RFG2-032-3G	1.25" W x 4" H	Clear	100

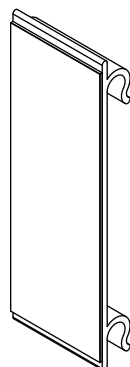

3" Grid Adhesive Sign Holder

- Designed to fit on 3" grid panels.
- Holds header signs on grid walls.
- Uses 3.5" x 1.25" permanent adhesive pad for strong holding power.
- Curved snap feature allows for easy installation.
- Fits wire grids with .224" thick wire.

Item No.	Ref. No.	Dimensions	Finish	Pack
0400386130	214817	3.75" H x 1.25" W x 0.68" D	Clear	6



Universal Upright System

Hang shelving and other retail merchandising displays with ease using the Universal Upright System. The universal upright can be installed on any gondola or mounted to a wall (hardware not included for wall mount).

The wire-frame hanging shelves set up quickly and are ideal for lightweight product displays such as chips and other snacks. Shelves are available in single or two-tiered displays. Wire shelf dividers are also available and can be installed all along the shelf to better manage and organize the merchandise.

Universal Uprights

- Install retail displays anywhere in your store
- Easy to set up
- Lightweight and sturdy
- Includes S-hooks for mounting

Universal Upright Display Shelves

- Single or double tiered
- Easy install – no mounting hardware required
- Shelf dividers also available

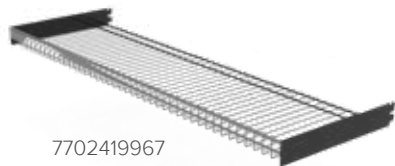

7702419967

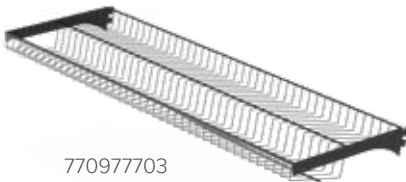

770977703



7705976131



7702958040



7706756685



7906000409



Item No.	Ref. No.	Style	Dimensions	Finish	Pack
7906000409	R-UNV48UR-K	Upright	46" L	Black	2
7702419967	R-UNV1T16-48-K	Single-Tier Shelf	16" D x 48" W	Black	1
7705977703	R-UNV2T-1548-K	Double-Tier Shelf	15" D x 48" W	Black	1
7705976131	R40-UVHB-48-K	Hanging Basket Display	6" T x 7.2" D x 48" W	Black	1
7702958040	R40-1TD-K	Single-Tier Divider	2.7" T x 14" L x .5" W	Black	10
7706756685	R40-2TD-K	Double-Tier Divider	5.3" T x 14" L x .5" W	Black	10



new

Impulse QueueLane™

The new Impulse QueueLane™ from siffron combines retail displays with queuing management in a sleek, effective system for retailers to revitalize their front end. Impulse QueueLane™ transforms customer lines into retail opportunities by offering more display space to showcase point-of-purchase impulse items or special product promotions. Retailers can make their checkout counters work for their bottom line by increasing sales and controlling store traffic.

- Increase sales of point-of-purchase items
- Entice customers waiting in line
- Control store traffic
- Highly configurable to suit any retail environment
- Easy to assemble; no tools required
- Compatible with wire grid and slatwall hooks (see page 387)



The base kit consists of two stanchions with pedestal bases and a single merchandise grid.

Impulse QueueLane™ Setup

1: Lock center grids into stanchions' designated slots.



2: Add additional stanchions and centerpieces as needed.



Additional styles and custom solutions are available

Item No.	Ref. No.	Style	Dimensions	Finish	Pack
7603909663	RQL-ST3648-K	Starter Kit	48" W x 36" H	Black	1
7607481072	RQL-AS3648-K	Add-on Kit	48" W x 36" H	Black	1
7606423181	RQL-BW-13-K	Wire Bowl Display	13" Dia	Black	1
2208639817	R16-IMBOWL	Clear Bowl Display	13" Dia	Clear	1
7600274471	RQL-SHLF4810-K	Shelf Topper	48" W x 10" H	Black	1
7907993347	RQL-MSLF-1048-K	Metal Shelf	48" W x 10" H	Black	1

Grid Options and Accessories

Along with the basic starter grid and expansion panels, siffron offers other optional kits and configurations, along with many accessories to accommodate a variety of merchandise.



Top Shelf

Wire shelf installs on top of the grid to create additional merchandising space.

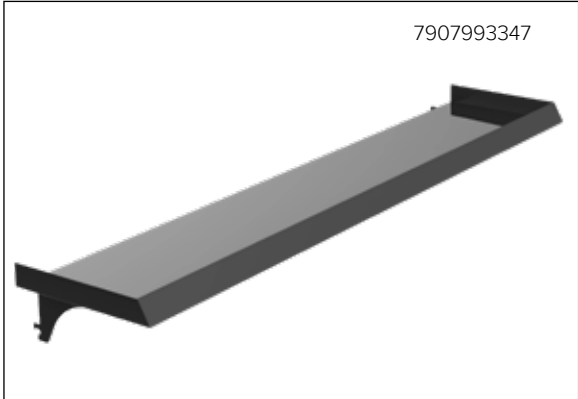

Metal Shelf

Mounts on wire grid to merchandise products. Has front lip for price marking and sign placement.

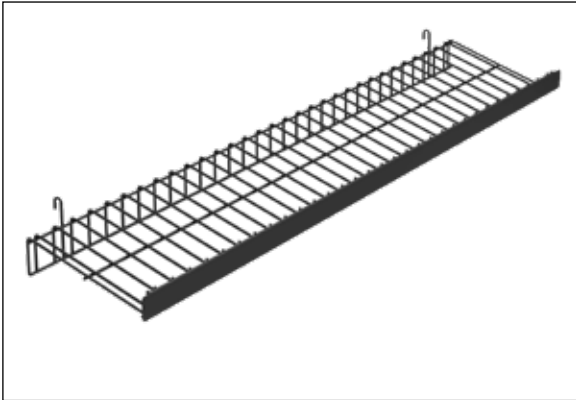

Wire Shelf

Mounts on wire grid to merchandise products. Has front lip for price marking and sign placement.

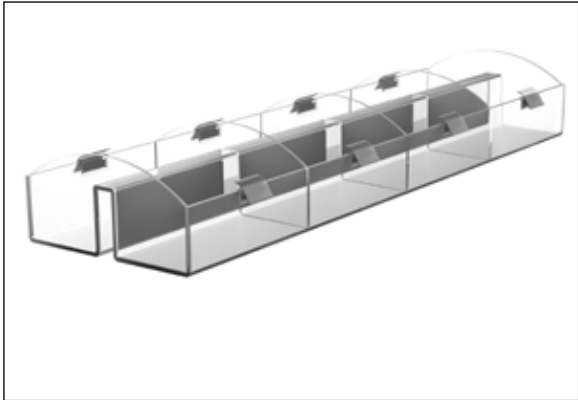

Acrylic Bin Saddle

Plastic display bins sit on top of the grid assembly for additional merchandising space.



Wire Bowls

Wire and clear plastic display bowls install on top of stanchions to showcase impulse items.



Plastic Bowls

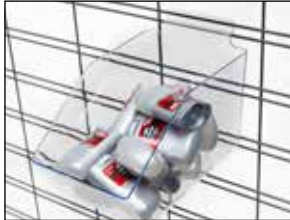

Visi-Bins™

Plastic display bins for merchandising bulk items. Available in different sizes and shapes
See pages 366-369



Hooks

Wire grid and slatwall display hooks available in scan (shown here) and stem hook versions..
See page 387

STOCK DISPLAYS



new

Bevy Rack™

The Bevy Rack™ is a free-standing display rack designed for stocking and displaying high volume beverages in coolers that is designed specifically to fit the full width of standard size cooler doors. Featuring adjustable shelves to accommodate a wide variety of different sizes of beverage containers, the Bevy Rack™ is perfect for cooler and dairy sections in grocery and convenience. Rear load access permits first-in, first-out rotation of fresh product to help manage expiration dates and reduce shrink.

The Bevy Rack™ features a steel frame with heavy duty coated wire shelves, reducing friction and insuring maximum flow of merchandise. The rack is also equipped with casters and two handles for easy mobility between locations. Wire shelves allow for minimal surface contact to limit areas where liquid/spilt product can collect to help keep the display rack clean.

Accessory Options

- Motion Mat overlay
- Roller Track overlay
- Adjustable wire dividers
- Bolt down bracket – for securing to floor
- Drip pan – for easy clean outs
- Leveler



Item No.	Ref. No.	Description	Dimensions	Finish	Pack
7702433036	-	Bevy Rack Frame	30"W x 36"D	Black	1
7702453036	-	Bevy Rack Shelf - Milk	30"W x 36"D	White	1
7702600036	-	Bevy Rack Wire Push Over Divider	36"D	White	18
7702683036	-	Bevy Rack Drip Tray	30"W x 36"D		2
4708283610		RTHL Roller Mat	27.28"W x 35.43"D	Gray	4
4702236930		RTHL Wire Divider	3"H x 35.4"D	White	18
4701927100		RTHL Front Lens	27"W x 17"H	Clear	
4701927300		RTHL Front Lens	27"W x 2.7"H	Clear	
4701927400		RTHL Front Lens	27"W x 4"H	Clear	

Call for details. Minimum quantities may apply.

Mobile Two-Tier Wire Dump Bin

- Heavy-duty wire dump bin can be used anywhere for long-term or temporary displays
- Ideal for cross-merchandising promotional items
- Includes two 18" W x 12" D x 10.25" H baskets; inner dimension is 17.25" W x 11.125" D
- Baskets feature three built-in sign channels to hold paper signs: Front holds 7" H x 11" W sign and each side holds 3.5" H x 5.5" W signs
- Overall size 20" W x 13" D x 47" H
- 2" diameter caster wheels provide easy mobility
- Includes two locking casters on front and two non-locking casters on back
- Black coated wire



Item No.	Ref. No.	Dimensions	Finish	Pack
9923219361	-	20" W x 13" D x 47" H	Black	1

Chip Display Rack

- Freestanding rack can be displayed in the center of the sales floor for easy access from two sides
- Shelf depth: 25"
- Includes casters for easy mobility
- Integrated price channels on two sides
- Knockdown capable for easy storage and shipping



Item No.	Ref. No.	Dimensions	Finish	Pack
7702701494	R-KDR-5TRR-K	63.5" H x 31" W x 25" L	Black	1

Mobile Display Rack

- Freestanding rack features angled shelves to keep product faced and accessible
- Shelf depth: 14"
- Includes casters for easy mobility
- Integrated price C-channels
- Side channel included for promotional signage and graphics

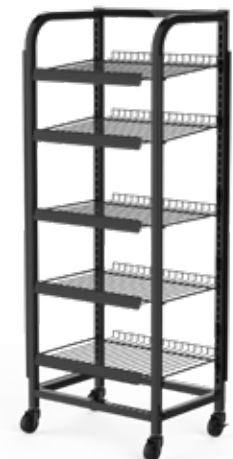

Item No.	Ref. No.	Dimensions	Finish	Pack
7707715153	R-KDR-DGBR-K	52" H x 20" W x 14" L	Black	1

5-Tier Candy Display



- Tiered shelf lengths: 8.33" to 4.15" D
- Features integrated plastic price channels
- Lightweight and easy to set up
- Ideal for countertop merchandising

Item No.	Ref. No.	Dimensions	Finish	Pack
7707857482	R-CT5-1521-K	21" H x 15" W x 8.3" L	Black	1

Single Panel Countertop Grid Assembly

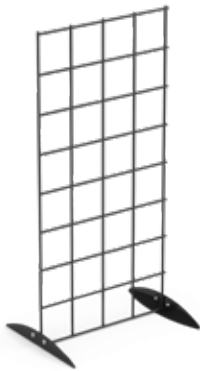

- Sturdy wire frame design
- Lightweight and easy to set up
- Single piece assembly – no tools required
- Use RGS-6-K Grid Hooks and Label Holders



Item No.	Ref. No.	Dimensions	Finish	Pack
7702705798	R40-CT-25GRD-K	24" H x 12" W x 9" L	Black	1
7143418854	RGS-6-K	6" L x .212" Dia.	Black	100

Countertop Tri-Grid Assembly

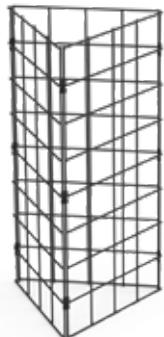

- Sturdy wire frame design
- Lightweight and easy to set up
- Ideal for countertop merchandising
- Use RGS-6-K Grid Hooks and Label Holders
- No tools or fasteners required to assemble



Item No.	Ref. No.	Dimensions	Finish	Pack
7706180993	R40-CT-TGRD-K	24.2" H x 12.6" W x 10.9" L	Black	1
7143418854	RGS-6-K	6" L x .212" Dia.	Black	100



7-Tier Candy Rack

- All hardware for assembly included.
- Knocks down and ships flat.
- 7 tiered shelves for product displays.
- Installs directly onto gondola or aisle end caps.

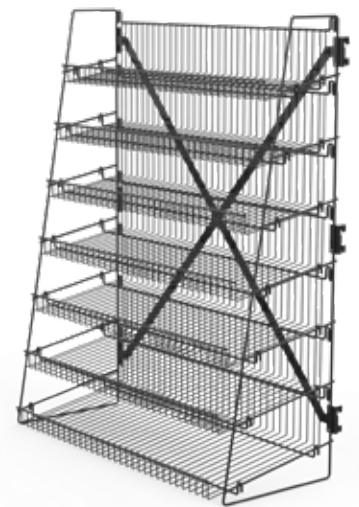

STOCK DISPLAYS

Item No.	Ref. No.	Dimensions	Finish	Pack
7708905215	R-KDR-7T36-K	45" H x 36" W	Black	1
7702838727	R-KDR-7T48-K	45" H x 48" W	Black	1



Soda Rack

- Shelf Depth: 20.5"
- Each shelf features four facings and five wire dividers
- Features three angled shelves for gravity facing
- Each shelf features integrated shelf channel
- Easy to set up
- Knockdown capable for easy storage and shipping

Item No.	Ref. No.	Dimensions	Finish	Pack
7701792539	R-KDR-4SR-K	57" H x 24" W x 24" L	Black	1

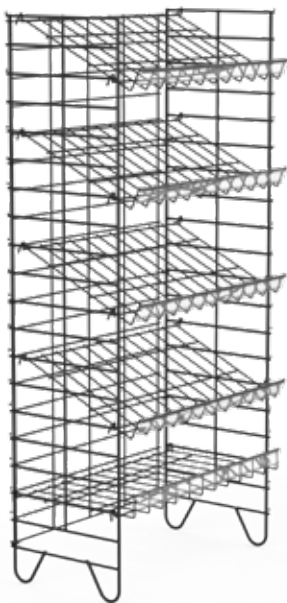

Adjustable Wire Display Rack

- Angled shelf design for easy loading and accessibility
- Adjustable shelf height
- Perfect for light to medium impulse items
- Integrated price C-channels
- Knockdown capable for easy storage and shipping
- No tools or fasteners required to assemble

Item No.	Ref. No.	Dimensions	Finish	Pack
7700211879	R-KDR-CRSQ-K	51.5" H x 24" W x 15" L	Black	1

Folding Magazine Rack

- Shelf Depth: 12"
- Easy to set up
- Perfect for holding newspapers, magazines and other literature
- Knockdown capable for easy storage and shipping
- No tools or fasteners required to assemble

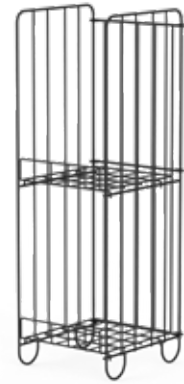

Item No.	Ref. No.	Dimensions	Finish	Pack
7703522799	R-KDR-MR-K	33" H x 10" W x 12" L	Black	1

4-Tier Round Display Rack

- Features four round wire display baskets
- Conserve space
- Display point-of-purchase items at various heights
- Knockdown capable for easy storage and shipping



Item No.	Ref. No.	Dimensions	Finish	Pack
7708983816	R-KDR-R4T12-K	54" H x 12" Dia.	Black	1

Square KD Rack

- Rack breaks down and ships flat to reduce shipping costs
- Product is accessible from both sides
- Shelves are placed in fixed locations
- Powder coated white; custom colors available
- Includes five shelves per unit
- No tools or fasteners required to assemble

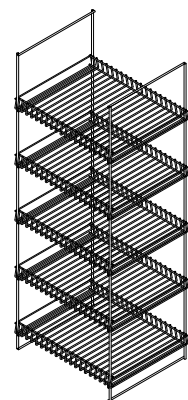

Item No.	Ref. No.	Dimensions	Finish	Pack
7701204795	R-KDR-60SQ	21" W x 55.25" H x 16.5" D	White	1

Round KD Rack

- Racks breaks down and ships flat to reduce shipping costs
- Product is accessible from one side
- C-Channels are attached to each shelf for 1.25"H labels
- Shelves are able to adjust to multiple locations
- Powder coated white; custom colors available
- Includes five shelves per unit
- No tools or fasteners required to assemble

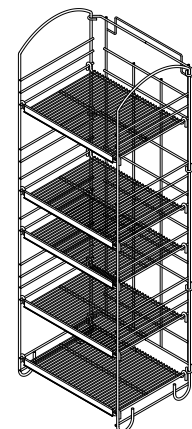

Item No.	Ref. No.	Dimensions	Finish	Pack
7700681165	R-KDR-60RD	19.25" W x 55.75" H x 15.25" D	White	1

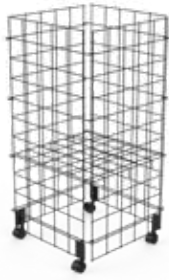

7703625343

Small Economy Dump Bins

- Collapsible lightweight design allows for easy setup, breakdown, packing, and storing
- Frame spacing allows for lifts to be used during store resets
- Includes adjustable shelf and four 2.5" dia casters (2 locking) for easy mobility
- No tools or fasteners required to assemble

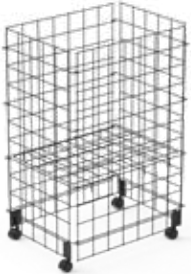

7702259565

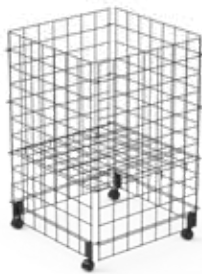

7703395504

Item No.	Ref. No.	Dimensions	Finish	Pack
7703625343	R40-ECDB-1616	32" H x 16" L x 16" W	Black	1
7702259565	R40-ECDB-1624	32" H x 16" L x 24" W	Black	1
7703395504	R40-ECDB-2323	32" H x 23" L x 23" W	Black	1



Large Economy Dump Bins

- Collapsible design allows for easy setup, breakdown, packing, and storing
- Frame spacing allows for lifts to be used during store resets
- Features adjustable shelf
- No tools or fasteners required to assemble

Item No.	Ref. No.	Dimensions	Finish	Pack
7704371722	R40-CLDB-3636-K	32" H x 36" L x 36" W	Black	1
7706344107	R40-CLDB-4848-K	32" H x 48" L x 48" W	Black	1

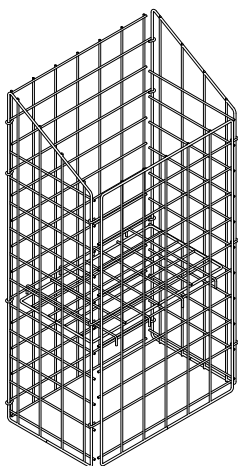

Endcap Dump Bin

- Shelf is adjustable to multiple depths.
- End cap bin is collapsible for flat shipping and reduced shipping rates.
- No tools or assembly brackets required for installations.
- Two can be used back to back to create an effective aisle display.
- Powder coated: Silver. Custom colors available.
- .224" frame wire with .77" cross wire.
- No tools or fasteners required to assemble

Item No.	Ref. No.	Dimensions	Finish	Pack
7701420861	R40-CLDB-ANG	38.75" H x 19.75" W x 12.15" D	Silver	1

Square Dump Bin

- Dump bins ship flat, require no tools and few components, and set up in minutes.
- Overall height of 32" with a 24" x 24" footprint.
- Adjustable shelf height every 6".
- Collapsible design allows for easy set-up, break-down, packing and storing.
- Powder coated silver for long lasting, durable finish. Custom colors available.

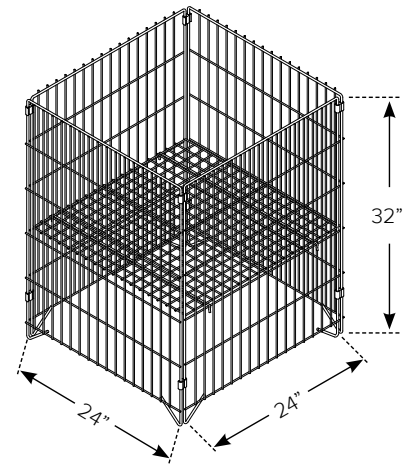

Item No.	Ref. No.	Dimensions	Finish	Pack
7706017735	R40-CLDB-SQ	24" L x 24" W x 32" H	Silver	1

Rectangular Dump Bin

- Dump bins ship flat, require no tools and few components, and set up in minutes.
- Overall height of 32" with a 14" x 24" footprint.
- Adjustable shelf height every 6".
- Collapsible design allows for easy set-up, break-down, packing and storing.
- Powder coated silver for long lasting, durable finish. Custom colors available.

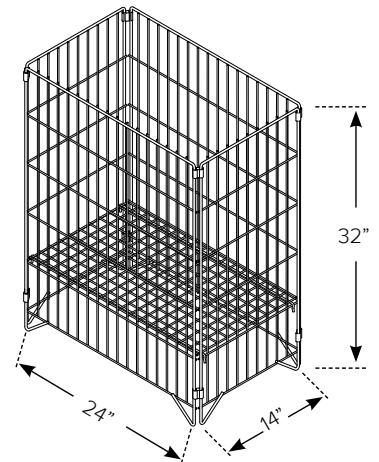

Item No.	Ref. No.	Dimensions	Finish	Pack
7709778089	R40-CLDB-REC	24" L x 14" W x 32" H	Silver	1

Wire Dump Bin Connectors

- "W" shaped design allows for easy installation.
- Manufactured with Butyrate - for strength and clarity.
- Snaps on for tight fit and a fast hold.

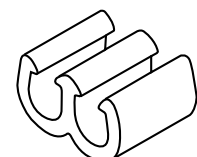

Item No.	Ref. No.	Dimensions	Finish	Pack
7901280201	RWC250X1	1" L x .75" W x .5" H	Clear	100

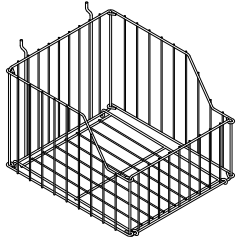

Collapsible Wire Basket

- Ships flat, require no tools and is set-up quickly and ready to merchandise.
- Baskets install into standard pegboard.
- .149" support wires reduce sagging when loaded with heavier products.
- Fit three baskets evenly across a 3' gondola and four across a 4' gondola.
- 12" W x 13" D x 9.5" H with 5.85" H front.
- 1.25" wire spacing on the front, bottom, and back.
- 1.315" wire spacing on the sides.
- Powder coated black.



The basket folds flat for low cost shipping and storage.

Item No.	Ref. No.	Dimensions	Finish	Pack
7704876932	R40-CLB-1213	12" W x 13" D x 9.5" H	Black	10

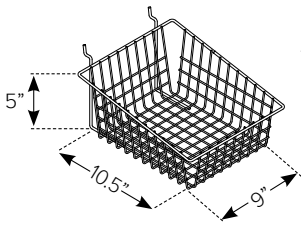

7708195492

Wire Baskets

- Works in peg paneling and slatwall.
- Small holes prevent product from falling through.
- Custom colors available. Call for details.

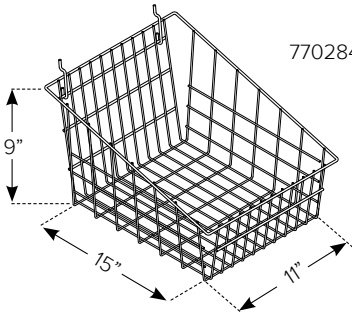

7702845396

Item No.	Ref. No.	Dimensions	Finish	Pack
7702845396	R40-LG-BSKT	9" H x 11" W x 15" D	Chrome	12
7708195492	R40-1728-A	5" H x 9" W x 10.5" D	White	20

STOCK DISPLAYS



Endless Baskets

- Durable chrome finish.
- Extra large basket can also be used as a shelf.
- Dividers can be placed anywhere within basket.
- Two sizes available to fit a variety of store fixtures.
- Includes two dividers, two ends, and mounting hardware.
- Stackable.

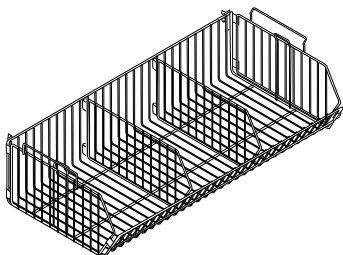

Item No.	Ref. No.	Dimensions	Finish	Pack
7701638506	R-9023037	16" D x 9" H x 36" L	Chrome	4
7706164423	R-9023045	16" D x 9" H x 48" L	Chrome	4
7703581011	R-9023102	16" D x 9" H Divider	Chrome	10

Quick-Shelf Brackets

- Holds videos, frames and other square shaped items.
- For pegboard use only.
- Pack includes left and right brackets.
- Constructed of durable clear polystyrene with stamped metal backs.

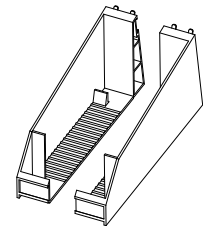

Item No.	Ref. No.	Dimensions	Finish	Pack
7709986191	R16-QSHLF	1.875" W x 5.25" H x 11.875" D	Clear	12 Pair

Adjustable Wire Wall Brackets for Pegboard

- A quality solution for displaying odd sized products on pegboard and slatwall.
- Expandable to any width.
- Heavy-duty four-prong back provides added stability.
- Stock colors include white and almond.
- Custom colors available.
- Sold in pairs.

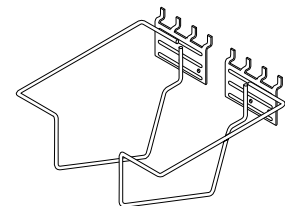

Item No.	Ref. No.	Dimensions	Finish	Pack
7708999820	RBR4-AWB-W	12" L x 4.5" W x 8" H	White	10 Pair



RSC-0007 Clips onto Basket

Wicker Basket Displays – Stands

Versatile stand configurations are available to meet a wide variety of store needs. Display stands are designed for wicker baskets to drop right into place. No additional components or fasteners necessary. Wicker Basket Displays can be disassembled quickly and knock down for easy storage and shipping. Units are packed 1 per box and are dishwasher safe for easy cleaning.

- Multi-tiered (2 or 3 levels)
- Sturdy wire-formed structure
- Brown synthetic wicker baskets
- Great for impulse buy displays
- Baskets are food grade quality and dishwasher safe
- Square baskets are 13" L x 13" W x 4" D
- Round baskets are 15" dia x 4" D
- A variety of Swivo-Clip™ Sign Holders are available (call for details)
- Custom Wicker Basket Display are available (call for details)

Item No.	Ref. No.	Style	Overall Dimensions	Pack
7704590673	RWKR-3TSF	3-Tier Square	38" H x 13.5" W x 16" D	1
7701462438	RWKR-3TRF	3-Tier Round	38" H x 15" W x 16" D	1
7707461315	RWKR-2TRF	2-Tier Round	26.8" H x 15" W x 16" D	1

Wicker Basket Displays – Counter Displays

Single-piece counter top wicker basket displays are also available. These smaller displays work particularly well for convenience stores when promoting produce, sandwiches, or other perishable items.

- Versatile basket options
- Natural-looking display
- Perfect for smaller promotions
- Brown synthetic wicker baskets
- Baskets are food grade quality and dishwasher safe
- RWKR-1TSCL Basket is 24" L x 14" W x 3" D
- RWKR-1TSC Basket is 14" L x 10" W x 3" D
- RWKR-2TSC Baskets are 14" L x 10" W x 4" D



7706506056



7709579343



7701903128

Item No.	Ref. No.	Style	Overall Dimensions	Pack
7706506056	RWKR-1TSCL	1-Tier Large Rectangle	9" H x 24" W x 16" D	1
7709579343	RWKR-1TSC	1-Tier Rectangle	7" H x 14.5" W x 16" D	1
7701903128	RWKR-2TSC	2-Tier Rectangle	16.6" H x 14.5" W x 16" D	1

Wicker Basket Displays – Liners

Clear plastic liners for wicker baskets are also available for fast clean-up. Some types of merchandise (fresh produce) can leave behind residue or other particulates. Plastic liners fit snugly within the wicker baskets and do not detract from store branding or basket display. To clean, simply remove merchandise and plastic liner, use siffron's Power Clean solution on a clean paper towel for safe, effective cleaning.

- Protects basket display integrity
- Easily removable
- No extra fasteners required
- Hygienic and food-grade quality
- Use Square Liner with 3-Tier Square Baskets



Item No.	Ref. No.	Style	Dimensions	Finish	Pack
7706921287	RWKR-LNR1414	Square	12" L x 12" W x 3.5" D	Clear	10



Wire Racks

- 4-Tier Racks
- 24" and 18" Depths available.
- 4' Wide x 62" H. Other custom sizes available.
- Durable chrome finish.
- Powder coat colors available.
- Other options available.
- No tools or fasteners required to assemble

Item No.	Ref. No.	Dimensions	Finish	Pack
7609058659	R40-MTR-486218	48" W x 62" H x 18" D	Chrome	1



Bag Display Stand

- The main display bar features multiple positions for placing the display arms, so the height of the arms can be adjusted to maximize merchandising space.
- Six arms are included in the kit to create three tiers of display area.
- The knock-down design of the display also reduces shipping and storage costs, so the display can be used seasonally and easily stored away.
- Features a Fast-Gripz™ sign holder for sign placement atop the display.

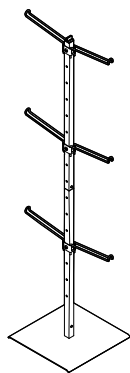

Item No.	Ref. No.	Dimensions	Finish	Pack
7601822691	R16-3TBAGHLDR-K	12.86" W x 54.84" H x 13" D	Black	1

STOCK DISPLAYS

The Next Generation in Stock Displays



Phone
Fax
Web

800.422.2547
800.422.2502
www.siffron.com

call toll-free in North America
fax us your purchase order
find and buy resources online

The Siffron logo features the word "siffron" in a bold, blue, sans-serif font. A small green diamond is positioned above the letter "i".

siffron[®]

See more great solutions
on our website!

www.siffron.com
800.422.2547